

1/35 MILITARY MINIATURE VEHICLE UPGRADE SERIES PEA432







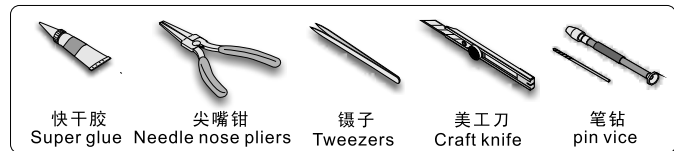

WWII German Pz.Kpfw.IV Ausf.G  
(LateProduction)Schurzen

二战德军IV号坦克G型后期批次附加装甲板

[For Boder 35001]

■推荐使用工具 RECOMMENDED TOOLS



-   
 安装  
install
-   
 折叠  
bend
- A1**  
 改造件零件编号  
PE/resin part number
- B12**  
 原零件编号  
kit part number
- C22**  
 被替换的原零件编号  
replaced kit part number
-   
 另一侧相同制作  
repeat on opposite side
-   
 切除  
remove
-   
 打磨  
grind off
-   
 弧度卷曲  
radial bending
- x2**  
 制作若干组  
multiple assembly
-   
 选择安装  
alternative
-   
 钻孔  
drill
-   
 用胶棒制作  
make from plastic rod

  
 用尖端在凹槽处冲压  
use penpoint to press on the dent

蚀刻片零件内侧面向上  
Put the part upside down

用笔尖在凹槽处刮  
Use penpoint to press on the dent

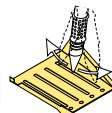
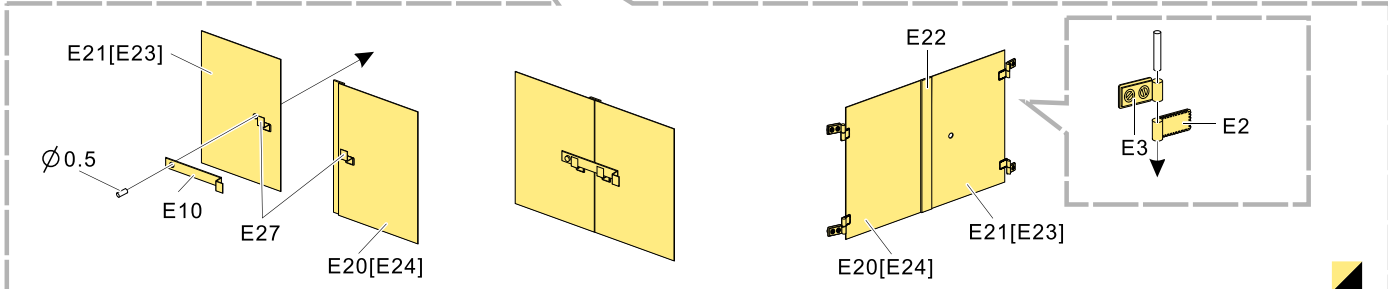
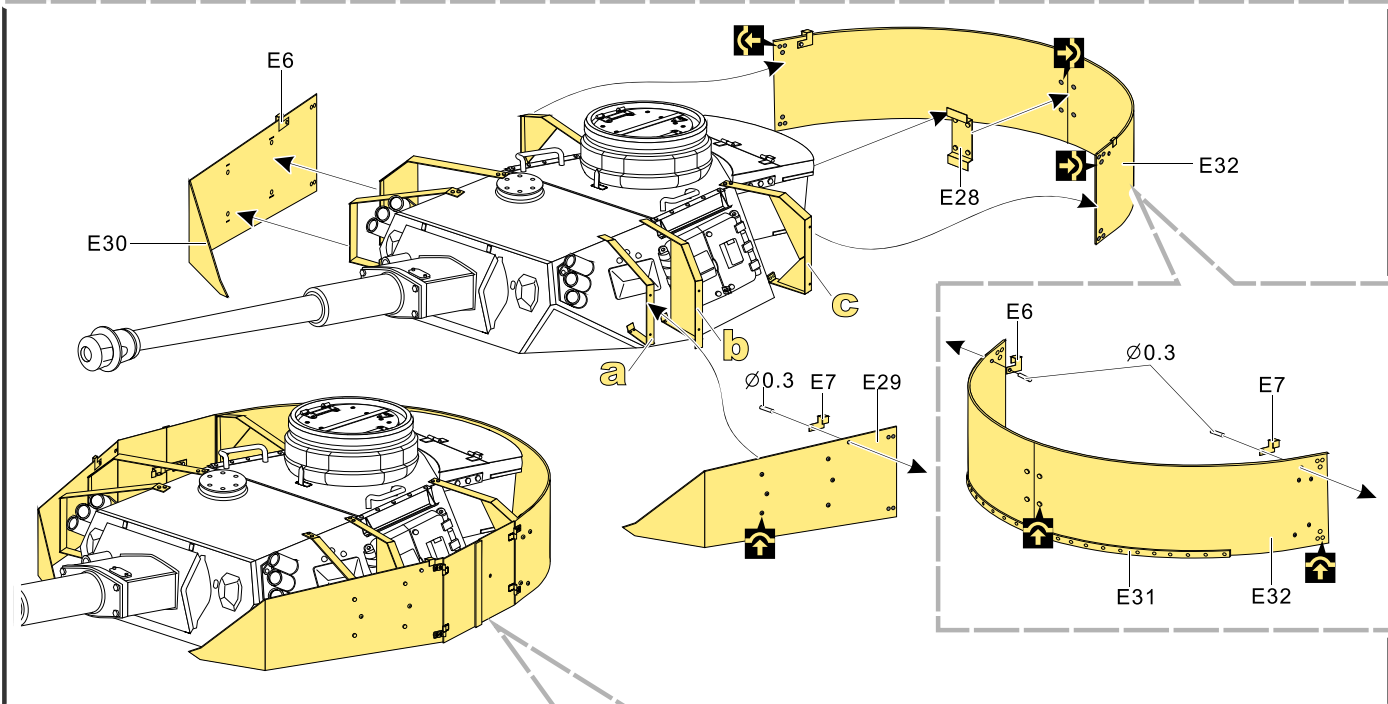
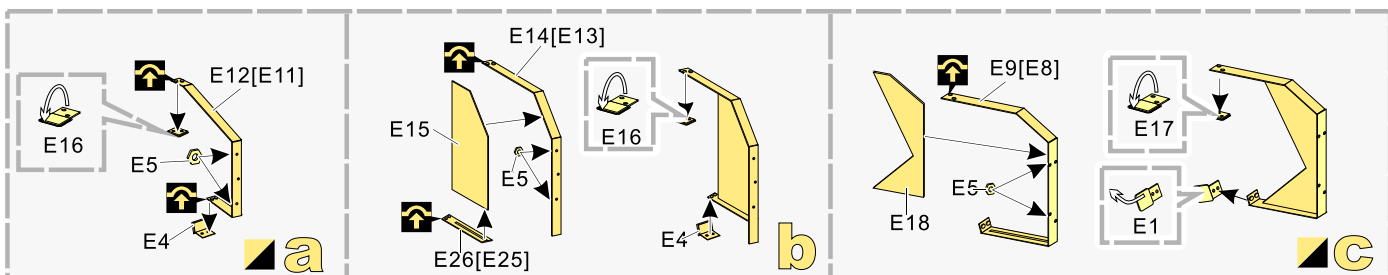
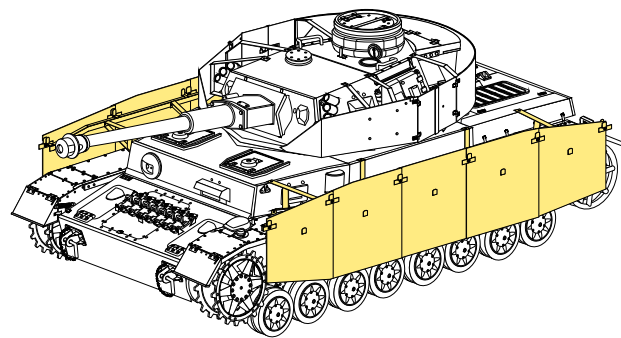
1/35 MILITARY MINIATURE VEHICLE UPGRADE SERIES PEA432

[Http://www.voyagermodel.com/productdetails.asp?itemid=PEA432](http://www.voyagermodel.com/productdetails.asp?itemid=PEA432)



**VOYAGER  
MODEL**



更多PEA 432样品照片参考请扫一扫  
MORE PICTUER OF PEA 432  
REFERENCE SCAN HERE

